

# Guidance – Two Roller Machines

© 2021 George Plint

---

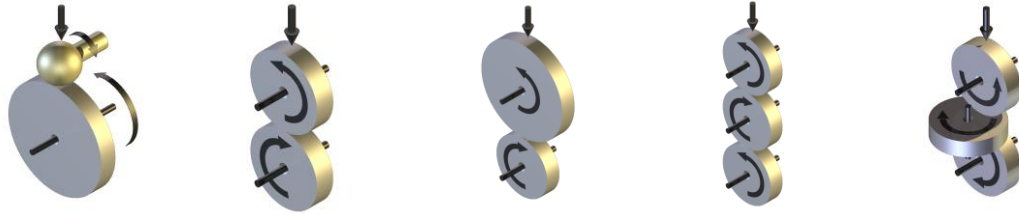

## Torque and Power Circulation

Two roller machines fall into two basic categories, those with mechanical torque circulation (rollers back-to-back with gears in a “four-square” configuration) and those with electrical power circulation (mechanically open loop).

Mechanical torque circulation pre-dates efficient and effective electrical power circulation and Phoenix Tribology has two machines that use this technique, the TE 53 Multi-Purpose Friction and Wear Tester and the TE 73H Two Roller Machine. With torque circulation, only a single drive motor is required, with sufficient capacity to drive the system losses only, in other words, to rotate the torque loop. It follows that the transmitted power through the tribological contact can be much higher than the motor input power with this arrangement.

Electrical power circulation first became properly feasible with the advent of the four quadrant d.c. thyristor drive, in which two identical motors are used, one driving and one absorbing, with the drives respectively drawing power from and regenerating power into the three phase supply. This works well, but is not electrically efficient. Because of phase angle effects between the supply current and the regenerating current, the supply has to have a capacity rated at the sum of the supply and regeneration current and not the difference.

In recent years, with the advent of the a.c. flux vector controller, we have ended up with a much more electrically efficient system, in which two vector controllers are supplied from a common d.c. bus, with one drawing power from and the other dumping power onto the bus. This means that the net electrical supply is limited more or less to the system losses, the difference between the driving and the regenerating power, with electrical circulation taking place entirely within the machine's power module. This system has replaced the former d.c. thyristor drive systems on all current open loop machines: the TE 54 Mini Traction Machine, the TE 72 Two Roller Machine, the TE 73S Two Roller Machine and the TE 74 Two Roller Machines.

With electrical power circulation, it will be apparent that in addition to providing the system losses, the motors used must have sufficient capacity to deliver and absorb the transmitted power and torque through the tribological contact. It follows that, unlike the circulating torque arrangement, the transmitted power through the tribological contact cannot exceed the capacity of the motors.

Now, it will be apparent that machines with two motors and electrical power circulation allow continuous adjustment of slide/roll ratio as the machine is running, whereas with back-to-back machines, the slide/roll ratio is fixed by the chosen gear ratio and thus cannot be adjusted while the machine is running. The preferential choice thus tends towards the flexibility of the two motor, circulating power solution. However, it will also be apparent that as the required torque or power capacity increases, usually as a result of wanting to use larger diameter discs and higher surface speeds, the size of the motors required will also increase, to a point where the twin motor solution becomes impractical. At this point, the only solution is to revert to a back-to-back gear design, but we are then left with the problem of how to achieve adjustment of the slide/roll ratio while the machine is running.

The TE 73H Two Roller Machine is a back-to-back, circulating torque design, but, uniquely, with variable slide/roll ratio at speeds up to 500 rpm. This is a large disc design, for accommodating rollers up to 300 mm in diameter, with loads up to 21 kN. Hence, assuming a traction coefficient of, say, 0.4, there is a requirement to generate a maximum torque of 1260 Nm and transmit 66 kW through the tribological contact. So, a twin motor solution would require two motors of at least 66 kW and a suitable reduction ratio drive. With the TE 73H design, the variable slide/roll ratio is achieved by using a speed modulating epicyclic gear-box as part of the torque loop. By driving the ring-gear on the output stage of the gear-box with a separate motor, a difference between input and output speed can be generated. Hence, the torsional stiffness and capacity of a four-square rig can be combined with continuously variable slide/roll ratio.

## Bearing Configurations

There are two basic configurations for mounting rollers in a two-roller machine, either with rollers mounted on the free end of shafts (overhung) or with the rollers mounted in the middle of shafts, supported by bearings on either side of the roller (fully supported).

## Overhung with Parallel Shafts

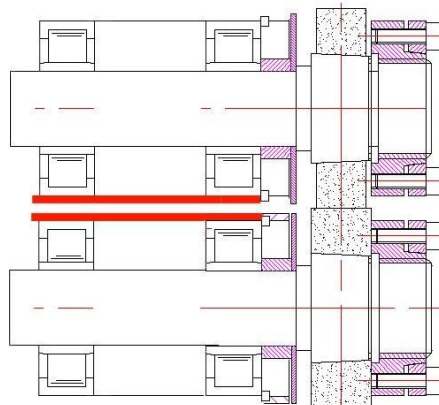

Overhung with Parallel Shafts

With overhung mounted rollers, the rollers may be removed and changed without disassembling the shaft. It is relatively easy to seal the shaft bearings from the test fluid.

## Fully Supported Design

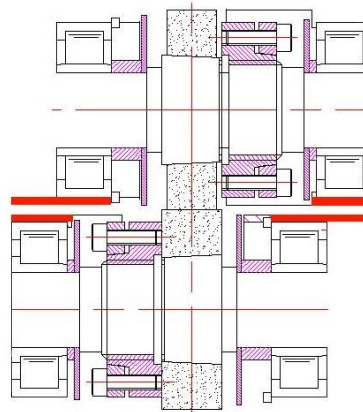

Fully Supported Shafts

With fully supported rollers, the shaft must be dis-assembled in order to change the rollers. It now becomes difficult to seal the shaft bearings from the test fluid, so one option is to run use the test fluid to lubricate the shaft bearings. This may place limits on the types of fluid that can be tested. Treating the bearings as consumable items is one potential solution.

It will be apparent that much higher loads can be achieved with the fully supported arrangement compared with the overhung arrangement.

## Overhung with Opposed Shafts

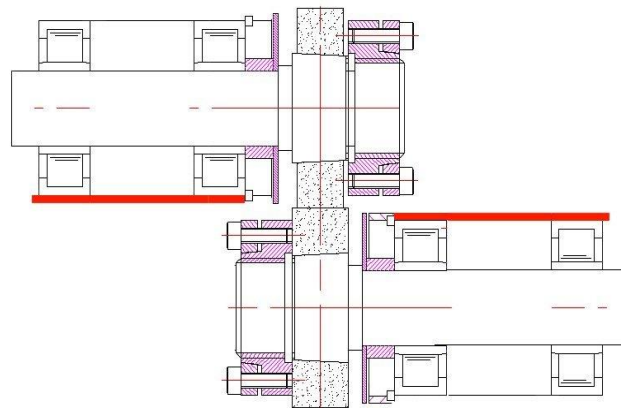

Overhung with Opposed Shafts

It will be apparent that in both the above cases, in order to accommodate the spindle bearings, the centre distance between the shafts must be greater than the mean outer diameter of the bearings. Obviously, the greater the shaft centre distance, the larger the resulting test rollers; for equal sized rollers, the roller diameter must be greater than the outside diameter of the spindle bearing.

The overhung with opposed shafts arrangement overcomes this shaft centre distance limitation, allowing smaller diameter rollers to be accommodated. However, the disadvantage of this type of arrangement is that the test chamber becomes much more complicated, compared with the overhung design with parallel shafts.

## Our Designs

Phoenix Tribology machines such as TE 54, TE 72 and TE 73 use the overhung roller arrangement, whereas machines such as TE 74S and TE 74H use the fully supported arrangement. In the TE 54 and TE 73 machines, the test spindles are mounted parallel to each other. In the TE 72 machines, the test spindles are mounted opposed to each other.

Both the TE 74S and the TE 74H have been optimised to give the maximum possible load with the minimum diameter roller. In the case of the TE 74S, the smallest available standard cylindrical roller bearing is used (Size 202), which has an internal diameter of 15 mm and an outside diameter of 35 mm. The dynamic load rating for this bearing is 12.5 kN. Fatigue life calculations indicate that it is acceptable to use two of these bearings mounted on either side of the test roller with a maximum applied shaft load of 12 kN, hence the TE 74S's specified load range. In order to mount two 35 mm outside diameter bearings in housings, the minimum practical shaft centre distance is 40 mm.

The TE 74H uses the smallest available spherical roller bearing (Size 22205), which has an internal diameter of 25 mm and an outside diameter of 52 mm. The dynamic load rating is 49 kN per bearing. With a specified maximum applied shaft load of 30 kN, an adequate bearing fatigue life is achieved. The minimum practical shaft centre distance could perhaps be as little as 60 mm, but in the case of the TE 74H this has been chosen as 70 mm to allow test rollers to be manufactured from standard 75 mm diameter stock material.

By contrast with the fully supported arrangement used in the TE 74 machines, with the overhung arrangement, the maximum loads permissible are correspondingly smaller. In addition to the bearing capacity and fatigue life, there are of course other considerations, of which the most significant is the rotating fatigue life of the test spindle. This is a particular issue with the overhung mounting arrangement and limits the maximum permissible shaft load.

## Manufacture of Test Rollers - Stock Material

Before choosing the size of roller, ensure that suitable sized stock material is available, bearing in mind that the finished roller diameter will always be less than the stock material diameter, so, for example, it is not possible to manufacture a 75 mm diameter roller from 75 mm bar stock, but it is of course possible to manufacture a 75 mm diameter roller from 3 inch (76.2 mm) bar stock.

## Self-aligning Flat on Flat Rollers

In the TE 74 machines, flat on flat alignment is achieved by incorporating a spherical bearing in the pivot arm of the upper test assembly. This is a key feature of this particular design and similar solutions are not possible on any of the other machines. In order to achieve self-aligning capability, hence correct line contacts, on machines other than the TE 74 designs, it is necessary to mount one test roller on a self-aligning bearing.

In the case of the TE 54, the lower roller is mounted on a spherical bearing allowing it to rotate. The TE 54 uses an upper roller of 25 mm diameter and a lower roller of 50 mm diameter. Driving pins are used to deliver traction from the drive shaft to the "floating" roller outer. This type of arrangement applied other machines of this type.

## Equal or Unequal Rollers

For rolling contact fatigue tests, it makes sense to use uneven diameter rollers. This is because the smaller roller is subjected to a higher number of contacts than the larger roller, hence failure tends to be confined to the smaller roller, which thus becomes the candidate sample.

It is of course more complicated to use rollers of different diameter, but it makes better sense experimentally.

## Elliptical versus Line Contact

Alignment issues are substantially eliminated (apart from skew and spin) if one roller is crowned. A crowned roller on a flat roller will produce an elliptical hertzian contact and will achieve a given hertzian contact pressure at much lower loads than the equivalent line contact, thus requiring lower torque and power. As a simple approximation, an elliptical contact will require about a fifth of the load and torque of a 10 mm wide line contact, thus significantly reducing both the required size of machine and the frictional energy input to the contact. Furthermore, the peak stress in the elliptical contact will be closer to the surface than with a line contact.

Although the pressure distribution in the direction of rolling is broadly similar for a line contact and an elliptical contact, the pressure distribution laterally is very different.

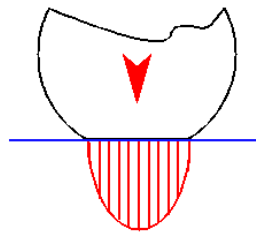

For an elliptical contact, the calculated peak pressure is central with an elliptical pressure distribution.

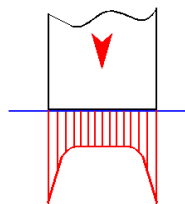

By contrast, with a line contact, although the nominal peak pressure appears over the middle section of the contact, geometric stress concentrations occur at either side of the contact, resulting in peak stresses far in excess of the nominal, calculated, peak pressure. The basic problem with calculating the maximum hertzian contact pressure for a line contact is that it is assumed that the contact is of infinite width and that the discontinuities at either end of the line contact can be ignored. Of course, in practical applications, geometric stress concentrations can be ameliorated by careful blending of the edges, as with cylindrical roller bearings.

## Entrainment, Side Leakage, Discharge of Fluids & Particles

The entrainment and discharge of fluids and particles is frequently treated as a two-dimensional problem and the assumption is thus that there is no material difference between an elliptical contact and a line contact. This is not the case.

The shape of the inlet to an elliptical contact allows fluid and particles to be displaced to either side of the inlet and thus flow past, as opposed to through, the contact. However, fluid and particles that have been successfully entrained within an elasto-hydrodynamic contact, will be constrained to discharge from the rear of the contact, with flow perpendicular to the plane of rolling contained by the pressure "horse-shoe". The pressure gradient outside the "horse-shoe" acts in such a way to eject particles and fluid from the side of the contact. This can lead to the rather unexpected situation, when running with a very shallow crown radius roller, of the asperities in the middle of the contact being satisfactorily separated by an EHD lubricant film, whereas the asperities immediately outside the "horse-shoe", lacking EHD separation, make contact.

With a line contact, the usual assumption is that one is dealing with a contact of infinite width, allowing no flow or pressure variation in an axial direction. This cannot be the case with a contact of finite width, with a stress concentration at either end of the contact. In this case, the pressure may act to cause flow in the direction of the centre of the contact, with the stress concentrations limiting discharge from either end of the contact.

## Dry Contacts - Saturation

A dry rolling-sliding contact is made up of zones of adhesion and micro-slip and the transition to full sliding is termed "saturation".

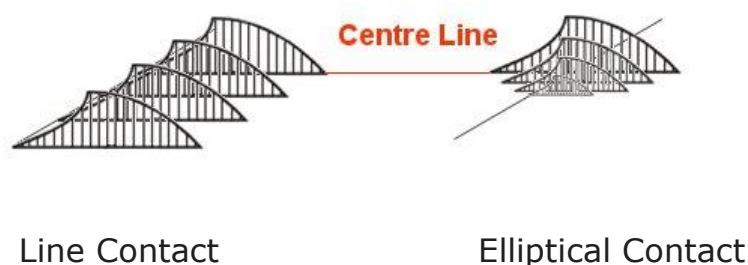

With an elliptical contact, the adhesion patch progressively decreases in size until it eventually disappears. It gets smaller and smaller in two dimensions, heading towards a singularity. With the elliptical contact, the decrease in the lemon-shaped adhesion zone with increasing creep will be asymptotic, but not so, with a line contact and certainly not so if one takes into account the geometric stress concentration at either end of a finite width line contact.

Now consider what happens if we have a line contact? The contact patch is rectangular and it will get smaller in one dimension only and this decrease will be essentially linear. Now think what happens at the moment when the patch is on the point of disappearing! It approaches a line, not a singularity! There is a step change at this point as opposed to a gradual change as seen with an elliptical contact and this may provide the mechanism to promote "chattering", which is common in line contacts as in spur gears. With an elliptical contact, the transition to gross slip will be smooth and potentially reversible, whereas with a line contact the transition will be somewhat more violent and not reversible. It probably does not matter what two roller machine one uses; a line contact is going to behave in this way and it will be different from an elliptical contact.

## Roller Design

Rollers must be manufactured in accordance with the relevant engineering drawings with tapered bores ground to match the shaft tapers. This is achieved by using the plug gauge supplied with the machine.

### Roller Centre Line

The contact centre-line of the roller will depend on the machine configuration. With a fully supported bearing arrangement, as per TE 74 designs, the roller contact will ideally align with the middle of the shaft taper.

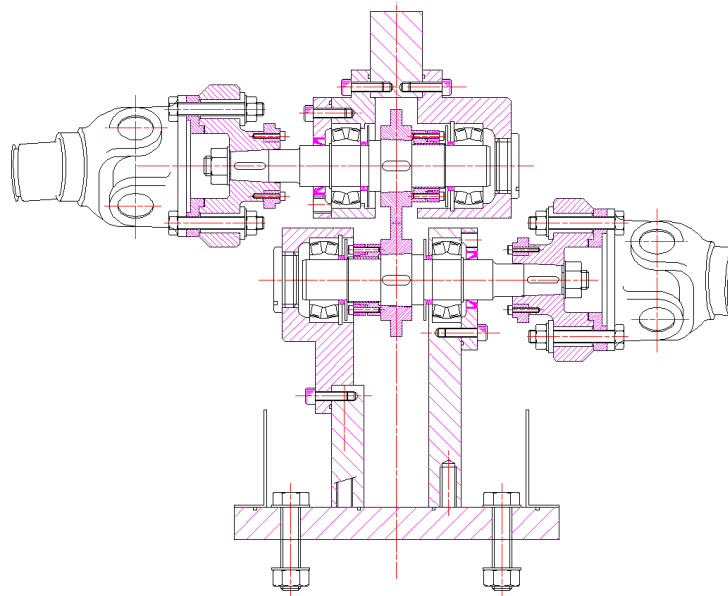

With an overhung bearing arrangement, with shafts mounted parallel to each other, as per TE 53, TE 54 and TE 73 designs, the contact centre-line should be as close to the bearing housing as possible, to minimize the over-hung load on the roller bearing.



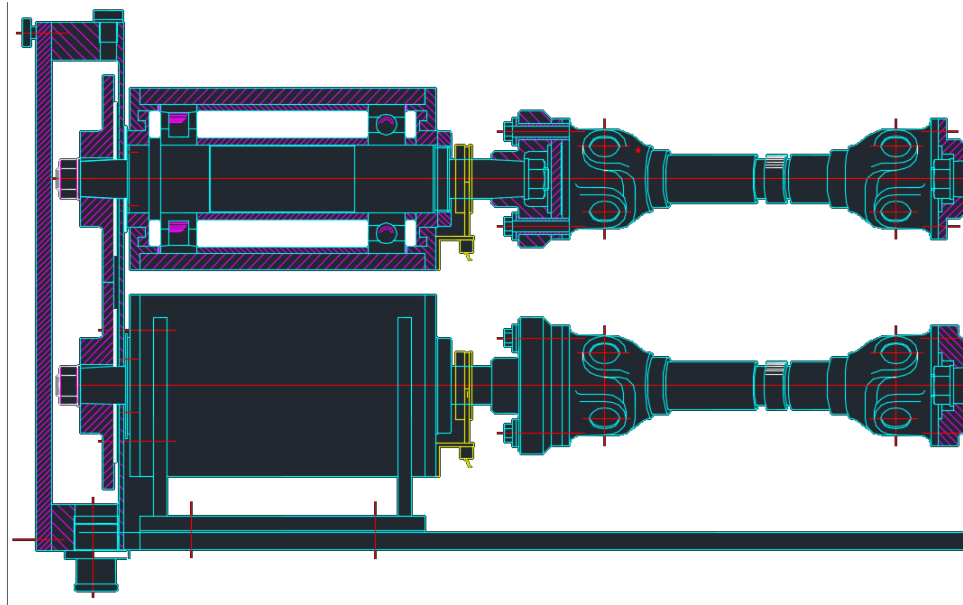

With an overhung bearing arrangement with shafts axially displaced and facing each other, as per TE 72 machines, moving the contact centre-line to be as close as possible to one bearing housing will simply exacerbate the problem at the other bearing housing. In this case, the roller contact will ideally align with the middle of the shaft taper. This is the limiting factor with regard to the maximum permissible load with this type of arrangement.

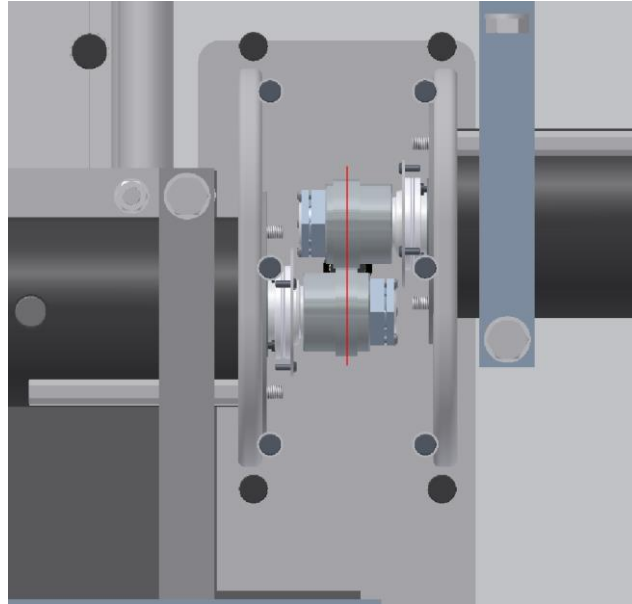

#### Width for Line Contact

If a line contact is required, note that with equal roller widths, care will be required if edge running is to be avoided.

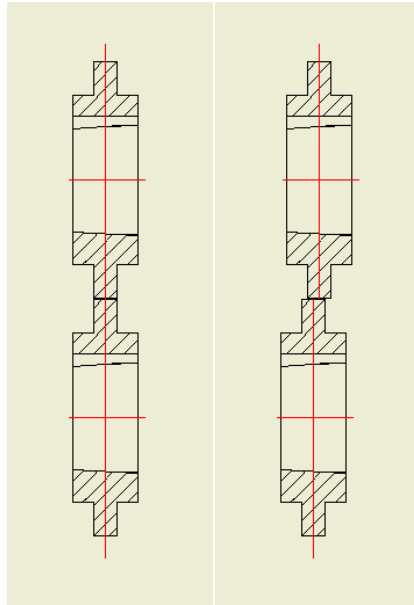

This will require careful adjustment of axial alignment and precise manufacture of roller tapers. One solution is to accept edge running but to confine it to one roller only, by making the rollers of different widths, for example a 10 mm wide roller running on a 12 mm wide roller. If the rollers are of different hardness materials, the wider roller should be the harder, in other words, avoid edge running with the harder material roller, as it will cut into the softer material.

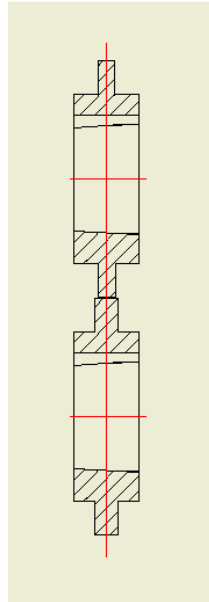

### Crowned Roller

Alignment issues are substantially eliminated (apart from skew and spin) if one roller is crowned. A crowned roller on a flat roller will produce an elliptical hertzian contact and will achieve a given hertzian contact pressure at much lower loads than the equivalent line contact, thus requiring lower torque and power.

As a simple approximation, an elliptical contact will require about a fifth of the load and torque of a 10 mm wide line contact, thus significantly reducing both the required size of machine and the frictional energy input to the contact. Furthermore, the peak stress in the elliptical contact will be closer to the surface than with a line contact.

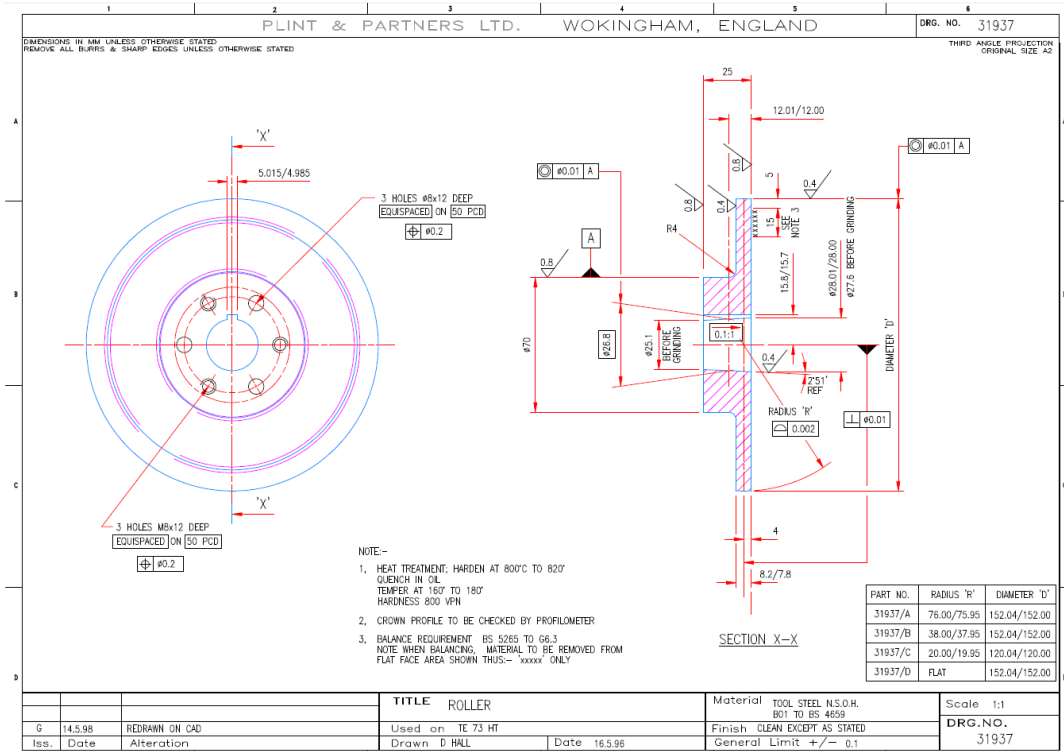

A typical design of crowned roller for an overhung bearing arrangement machine (TE 72 and TE 73) is shown above. The crowned radius may be anything achievable within the grinding process, however, the most common choice is to make the crown radius equal half the disc diameter. If two such crowned radius rollers are loaded against each other, the resulting hertzian contact will be circular as opposed to elliptical, in other words, the equivalent of running two balls of the same diameter as the rollers together in contact.

### Small Diameter Rollers

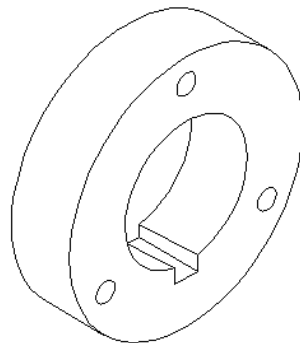

A limiting factor with small diameter rollers is the roller wall thickness, which typically should not be less than approximately 10 mm. Hard rollers in particular are liable to fail by radial cracking, initiated at the sharp edges in the key-way. For tests at low traction, it may be possible to use rollers without key-ways, but clearly there will be a risk of shaft damage through fretting, should a roller come loose.

For rollers where the diameter approaches the diameter of the supporting shaft, the solution is to use a combined, single piece, roller and shafts.

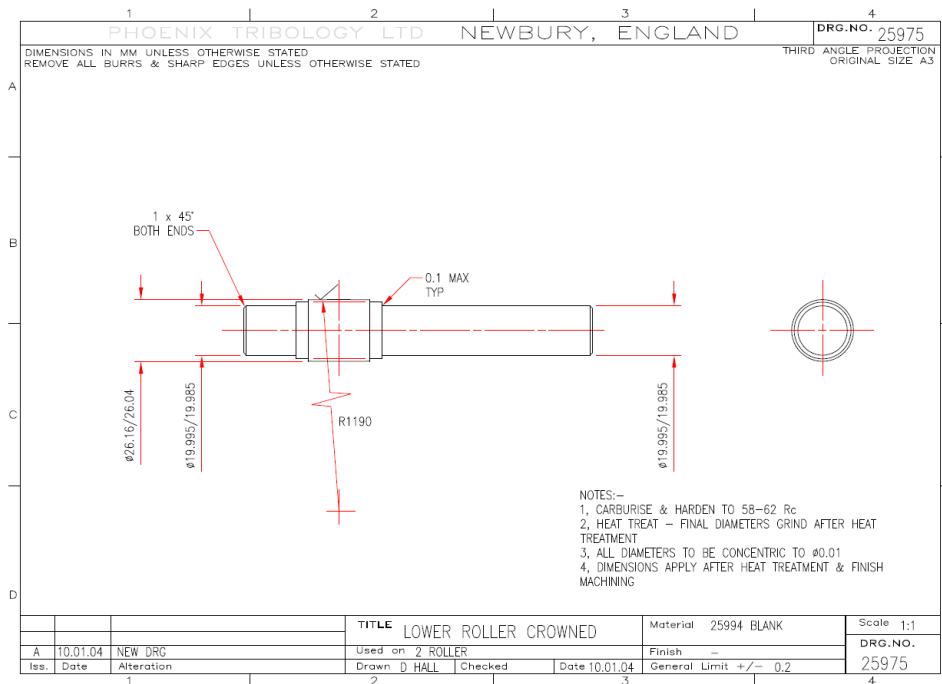

### Large Diameter Rollers for High Speed Operation

Test rollers are essentially just flywheels, in other words, energy storage devices. With the flywheel, unlike many other energy storage systems, the energy is instantly available, which is why they are hazardous devices. There are two reasons for minimizing the inertia of test rollers:

1. To minimize the stored energy.
2. To minimize the flywheel inertia and thus maximize the natural frequency of the system, to avoid torsional vibration.

For a disc radius  $r$  and thickness  $t$ , the stored energy can be calculated as follows:

$$\text{Moment of inertia } I = \rho \times \pi \times r^4 \times t / 2$$

$$\text{Energy stored } E = I \times \omega^2 / 2$$

$$\text{Where: } \omega = 2 \times \pi \times N / 60$$

Where:  $N =$  Rotational speed in rpm

When calculating the inertia of a stepped roller, this can be done by dividing the roller into cylindrical components, calculating their respective moment of inertia, then summing the total.

To calculate the torsional stiffness and natural frequency of the system, we would need to have detailed information with regard to all other elements in the drive train. However, as a general rule of thumb, if one end of the drive train unavoidably has high inertia, for example, because it is a motor armature or a large diameter gear, the best solution is to minimize the inertia at the other end of the drive train, in other words, at the test rollers. If there are issues with torsional vibrations, these can be addressed by introducing a slipping element into the design such as a clutch or, alternatively, some form of torsional damping.

It follows that for high speed applications with large diameter rollers, the width of the roller web should be minimized.

Balancing, where necessary, should be specified to be in accordance with BS ISO 1940-1:2003 to Balance Grade G6,3, with a half-key fitted.

Deciding when balancing is necessary is frequently done by trial and error, with practical determination of residual out-of-balance forces. Past experience proved it necessary to balance 150 mm diameter discs to Drawing Number 31937 for operations at speeds up to 3,000 rpm on TE 73 and 6,000 rpm on TE 103, the stored energy being respectively 168.5 J and 674.1 J.

As a general rule of thumb, we should set the following stored energy limits:

Maximum permissible stored energy:

Unbalanced Rollers:	100 J
Balanced Rollers:	1000 J

## Tapers

Plug gauges will be required for all tapered shaft mounting rollers.

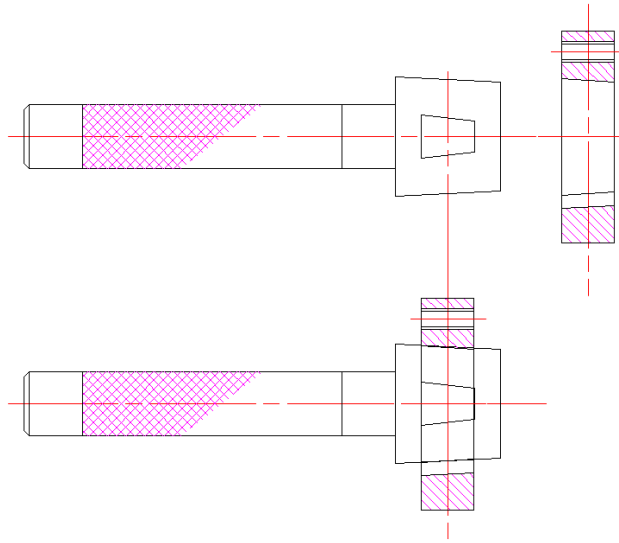

In addition to using the plug gauges to ensure that the tapers match, the gauges are also used to check the axial position of the roller on the shaft. The roller should fit onto the gauge so that it covers the gauge notch, as shown above.

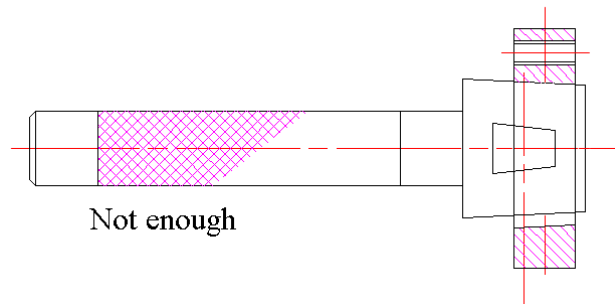

If the roller does not fit far enough onto the gauge, further grinding is required.

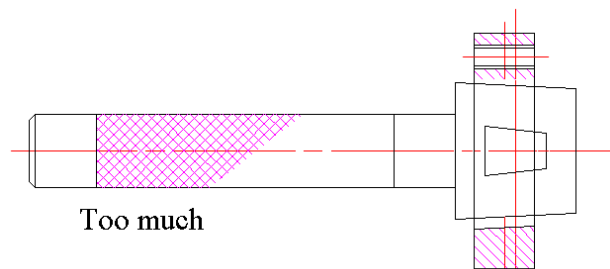

If too much material is removed, the roller must be scrapped

## Pullers

All rollers will require holes for three legged pullers as standard.

## Slide-Roll Ratio versus Slip

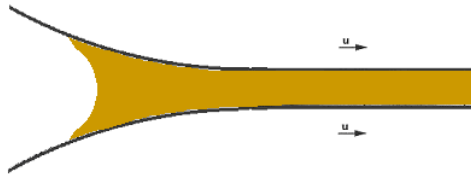

$$\text{Slide/Roll Ratio} = \text{Sliding Velocity} / \text{Rolling Velocity}$$

Where:

$$\text{Sliding Velocity} = |U_1 - U_2|$$

$$\text{Rolling Velocity} = \frac{1}{2} (U_1 + U_2)$$

For lubricated tests in a two-roller machine, where the axes of rotation are fixed, the **Rolling Velocity** is the same as the lubricant **Entrainment Velocity**.

Hence:

$$\text{Slide/Roll Ratio}\% = 200 \times |U_1 - U_2| / (U_1 + U_2)$$

This is the "preferred" definition of Slide/Roll Ratio and it means that for "pure sliding", in other words, for  $U_2 = 0$ , the **Slide/Roll Ratio = 200%**.

## Slide/Roll Ratio – General Solution

$$\text{Slide/Roll Ratio} = \text{Sliding Velocity} / \text{Entrainment Velocity}$$

In some circumstances, it is useful consciously to use the entrainment velocity as opposed to the rolling velocity, when analysing more complicated systems.

$$\text{Entrainment Velocity} = \frac{1}{2} \{ (U_1 - u_c) + (U_2 - u_c) \}$$

Where  $u_c$  is the speed of the contact patch, such that the Entrainment Velocity is the mean speed relative to the contact patch, as opposed to Rolling Velocity =  $\frac{1}{2} (U_1 + U_2)$ .

Consider rolling and sliding along a plane:

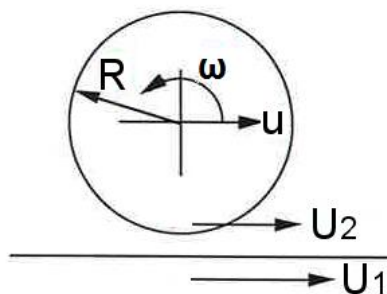

Where:

$$u_c = u$$

$$U_2 = u + R\omega$$

$$\begin{aligned} \text{Entrainment Velocity} &= \frac{1}{2} \{(U_1 - u_c) + (U_2 - u_c)\} \\ &= \frac{1}{2} \{(U_1 - u) + (u + R\omega - u)\} \\ &= \frac{1}{2} \{U_1 - u + R\omega\} \end{aligned}$$

Hence:

$$\text{Slide/Roll Ratio\%} = 200 \times (U_1 - u - R\omega) / (U_1 - u + R\omega)$$

If  $\omega = 0$  then Slide/Roll% = 200%, hence pure sliding.

If  $U_1 = u + R\omega$  then Slide/Roll% = 0%, hence pure rolling.

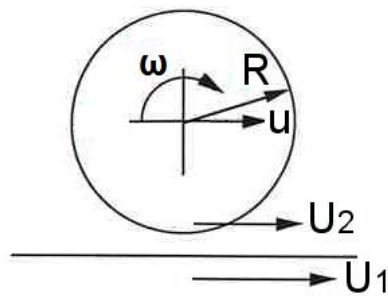

Reversing  $\omega$  direction:

$$\text{Slide/Roll Ratio\%} = 200 \times (U_1 - u + R\omega) / (U_1 - u - R\omega)$$

If  $\omega = 0$  then Slide/Roll% = 200%, hence pure sliding.

If  $U_1 = 0$ :

$$\begin{aligned} \text{Slide/Roll Ratio\%} &= 200 \times (-u + R\omega) / (-u - R\omega) \\ &= 200 \times (u - R\omega) / (u + R\omega) \end{aligned}$$

## Slip Ratio

Slip Ratio% is usually defined as:

$$\text{Slip Ratio\%} = 100 \times (\text{Vehicle Speed} - \text{Wheel Speed}) / \text{Vehicle Speed}$$

$$\text{Slip Ratio\%} = 100 \times |U_1 - U_2| / U_1$$

Hence, for "pure sliding", in other words, for  $U_2 = 0$ , the **Slip Ratio = 100%**.



$$\text{Slip Ratio} = \text{Sliding Velocity} / \text{Velocity of Larger Roller}$$

Nominate  $U_1$  to be the larger roller:

$$\text{Slip Ratio} = (U_1 - U_2) / U_1$$

Note:

Slip Ratio is a term that appears, as the definition might suggest, to be used mostly in the automotive industry, in particular with regard to traction control and anti-lock braking systems.

### Creepage

Creep occurs when one or other of the materials in contact undergo some tangential deformation. If, for example, a thin 'tyre' on the wheel stretches a bit as a result of the application of the normal pressure then in making one revolution the wheel will have advanced a bit more than  $2\pi R$ . Creepage is that extra bit as a percentage and there are regions of 'stick' and 'slip' within the contact.

There appears to be an alternative definition of Creep% used in the rail industry, which may be at odds with the above definition. This term is derived from the Slide/Roll equation:

$$\begin{aligned} \text{Slide/Roll Ratio}\% &= 100 \times (\text{Sliding Velocity}) / (\text{Rolling Velocity}) \\ &= 100 \times (V - R\omega) / 0.5 \times (V + R\omega) \\ &= 200 \times (V - R\omega) / (V + R\omega) \end{aligned}$$

Now, if  $R\omega$  is small, this is sometimes simplified to:

$$\text{Slide/Roll Ratio}\% = 200 \times (V - R\omega) / (V)$$

Hence Slide/Roll Ratio at low rates of sliding, sometimes (possibly) referred to as Creep%, is 2 x Slip Ratio%.